



HAL
open science

A Knowledge-Based Approach for Evaluating Impact of Therapeutic Strategies

Nadia Abchiche-Mimouni, Mike Donald Tapi Nzali, François Gueyffier

► **To cite this version:**

Nadia Abchiche-Mimouni, Mike Donald Tapi Nzali, François Gueyffier. A Knowledge-Based Approach for Evaluating Impact of Therapeutic Strategies. ICAART 2023 - 15th International Conference on Agents and Artificial Intelligence, Feb 2023, Lisbon, Portugal. pp.1036-1046, 10.5220/0011894300003393. hal-04015162

HAL Id: hal-04015162

<https://univ-evry.hal.science/hal-04015162v1>

Submitted on 6 Mar 2023

HAL is a multi-disciplinary open access archive for the deposit and dissemination of scientific research documents, whether they are published or not. The documents may come from teaching and research institutions in France or abroad, or from public or private research centers.

L'archive ouverte pluridisciplinaire **HAL**, est destinée au dépôt et à la diffusion de documents scientifiques de niveau recherche, publiés ou non, émanant des établissements d'enseignement et de recherche français ou étrangers, des laboratoires publics ou privés.



Distributed under a Creative Commons Attribution - NonCommercial - NoDerivatives 4.0 International License

A Knowledge-Based Approach for Evaluating Impact of Therapeutic Strategies

Nadia Abchiche-Mimouni¹^a, Mike Donald Tapi Nzali²^b and François Gueyffier³^c

¹Laboratoire IBISC, Univ. Evry, Université Paris-Saclay, France

²LIRMM, Department of Computer Science, Montpellier University, Montpellier, France

³LBBE, Université Claude Bernard Lyon 1, France

Keywords: Rule-Base Systems, Simulation in Healthcare.

Abstract: This paper proposes an original approach for modelling medical expertise and simulating medical strategies. A knowledge-based system is used to model therapeutic strategies according to three axes: diagnostic, prescription and treatment effect. The diagnostic axis describes the ways of deciding whether an individual is eligible for treatment or not. The prescription axis models the ways of choosing an adequate drug for an individual or changing the current treatment if it is judged ineffective. Treatment effect concerns the effect of a drug at the individual level. This modelling is used for exploring different therapeutic strategies and quantifying their impact on the individual and population levels. We have developed a platform, based on a rule-based system, that was validated with a Use-case in Hypertension management. Classical and Alternative strategies have been simulated with the same Realistic virtual population. 20.000 individuals were considered and several parameters (e.g. optimal drug prescription, evolution of the cardiovascular risk) were calculated. The experiments showed the viability and relevance of the approach. Its strengths are numerous. Since the rules are the input of the system, they can be introduced and modified by non-programmers people, allowing prescribers to fully test their own rules. The platform is configurable in terms of modelled expertise and in terms of outputs to be measured. Empirical results concerning the superiority of the Alternative strategies have been produced.

1 INTRODUCTION

Evidence-Based Medicine (EBM) is described as “the conscientious, explicit, and judicious use of current best evidence in making decisions about the care of individual patients” (Sackett et al., 1996). From the perspective of public health workers and policy-makers (Sheridan and Julian, 2016), it is more about having evidence or data on the impact of diagnosis and treatment at the population level. In this case, the impact of the cost factor is decisive. Clinicians need to access to different kinds of knowledge to take the decision which is the most adequate according to the patient’s state of health, environment and comorbidities. The patient’s individual preferences are also very important in order to ensure adherence to treatment.

This paper addresses an important challenge that EBM raised, that is providing means and/or tools for evidence-based decision making. Tools for public health workers and policy makers are particularly targeted. This allows physicians or policy-makers to formulate clinical recommendations and guidelines on the principles of EBM. Sillico modelling methods have proven to be very helpful while exploring (whilst more cheaply) the impact of therapeutic strategies. This concerns as well the individual level ((Gao, 2019), (Troche et al., 2000)), where the aim is to provide a personalized prescription, as well the population level ((Patel et al., 2021), (Kotecha et al., 2021)). In the later case, the aim is to consider collective benefits of the population in terms of efficiency and cost. In both approaches, balancing risk and benefit is an important question. The existing approaches are based on meta-analysis (Gao, 2019), randomized clinical (Duffy J and RJ, 2017), and/or on specific mathematical modelling ((Cottura et al., 2020), (Gumel et al., 2002)). Most of them are disease-specific or dedicated to sub-

^a <https://orcid.org/0000-0001-6149-3345>

^b <https://orcid.org/0000-0002-6245-5516>

^c <https://orcid.org/0000-0002-9921-0977>

problems of a disease. From another perspective, since the first well known medical expert system MYCIN, developed by Shortliffe (Shortliffe, 1976) (to help physicians when prescribing antimicrobial drugs) medical applications in Artificial Intelligence (AI) have been continually developed. AI has been extensively employed in medicine by modelling expertise thanks to Knowledge-Based systems and/or by treating medical datasets with Machine Learning algorithms (Nayyar et al., 2021). However, KBS AI methods have not been used for the evaluation of therapeutic strategies. Yet, healthcare applications are "knowledge-intensive" (Schreiber et al., 1999) i.e, knowledge and expertise play a key role.

The present work fills this gap by proposing a knowledge-based platform for modelling and simulating therapeutic strategies with a virtual population. Such a platform is proposed to help physicians and policy makers to respectively formulate individualized clinical decisions and, recommendations and guidelines on the principles of EBM. The simulation allows to illustrate and quantify the benefits and/or the impact of a therapeutic strategy. Moreover, it allows to compare different therapeutic strategies. The approach has been designed in collaboration with physicians who helped during the modelling process of the therapeutic strategies and during the experiments. It has been instantiated with an application in Hypertension management, where two therapeutic strategies and a given hypertensive virtual population are used. The first therapeutic strategy is the one which is consistent with the European official guidelines for Hypertension management ((Graham and AL., 2007), (Fagard and AL., 2013), (Unger et al., 2020)). Such a strategy is generally in accordance with what is -supposed- to be put into practice by physicians. It is named as Classical strategy. An Alternative strategy is able to consider alternative factors (risk, age, sex...) either for the diagnostic or the prescription.

In the present work, two therapeutic strategies (Classical and Alternative) for Hypertension management have been simulated and evaluated, allowing to quantify their benefits. The gain is measured for each strategy (e.g. in terms of blood pressure level decreasing, number of treated individuals), therefore enabling the quantification of the impact in terms of public health. The use of a virtual population allows one to consider different assumptions, through different settings, on large sizes of data cheaply and safely (Richard J. Chen, 2021),(Ivanny, 2018). The knowledge describing the strategies have been mod-

elled by means of production rules in order to make it possible to modify the strategies in a declarative way, i.e., without modifying the application program. Because it does not require advanced programming action, the physicians are able to introduce the strategies in the system by themselves. Physicians can also modify the implemented strategies and the parameters of the simulation.

The next section of this paper presents the necessary background for modelling Hypertension management. Section 3 describes the material and methods. Section 4 presents a Use-case showing the usability and preliminary results of the approach in Hypertension management. Section 5 provides a discussion according to the contributions and related work. Finally, the conclusion summarizes the contribution of this paper and proposes some improvements and perspectives for the future.

2 KNOWLEDGE MODELING

The considered domain application is related to Hypertension management. This is a major risk factor behind cardiovascular diseases, which is the largest causes of death in the world (Roth and al., 2020). For this reason, it is well studied and documented, resulting in a large source of expertise and data. The availability of home kits for self-measurement allows for collecting patients data easily. Official guidelines (Fagard and AL., 2013) offer clinicians guidance on Hypertension management using the best scientific evidence. Clinicians acquire some expertise from their everyday practice which is also important. Other sources of knowledge derived from physiology or medical genetics may also be available¹.

Different levels of knowledge representation can be considered while describing complex domain knowledge. The most popular is the one proposed in Richter (59), based on three different levels (see Figure 1). The first level is the Cognitive level. It contains the expression of the expertise in human and informal way. The second is the Representation level which implies the use of formal (logical) languages for expressing the knowledge. The third level is the Implementation level, which is machine-oriented (uses data structures and programs). As shown in Figure 1, there is a hierarchical relationship between the three levels, meaning that the Cognitive level requires

¹It is well known that Hypertension is often associated with other diseases. But, for simplification reasons, this will not be considered in this work.

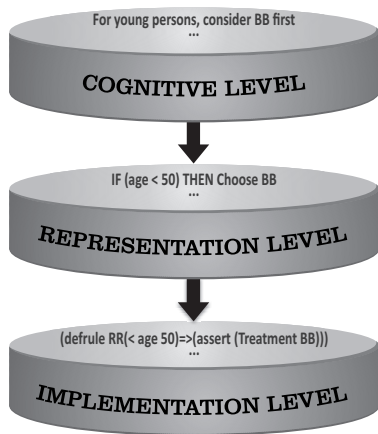

Figure 1: Three-levels modelling.

a translation to be expressed into the Representation level, which itself is translated into Implementation level. Other proposed methodologies (e.g. (Schreiber et al., 1999)) are more sophisticated, in terms of representation levels and modelled concepts. To simplify the discussions with the experts, this three-level modelling method has been adopted. As it will be shown in Section 3, the Cognitive level is used to express a set of therapeutic strategies a in Hypertension domain in a form close to natural language. The Representation and the Implementation levels are used to formalize these knowledge. Figure 1 shows an example that expresses the fact that the physicians use in general Beta Blockers drugs for young poeple.

2.1 Therapeutic Strategies

A Therapeutic Strategy (TS) is defined according to three dimensions: Diagnostic, Prescription and treatment Effect (DPE). Each dimension represents a par-

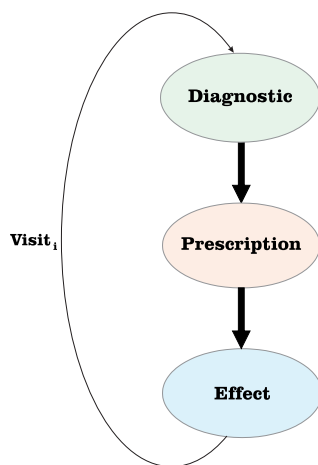

Figure 2: DPE Cycle visit.

ticular step of the global therapeutic process. Figure 2 shows the DPE cycle which is associated to a medical visit ($Visit_i$).

2.1.1 Diagnostic

It is the way of deciding whether an individual is eligible for treatment (i.e., the individual is considered to be hypertensive) or not. For example, a Classical strategy consists in considering only the Blood Pressure (BP) level to classify an individual as hypertensive. This is generally decided based on several visits to the doctor. An average of the measures is calculated and used for the decision. Instead of relying solely on the pressure level of BP for deciding that an individual is hypertensive, it also considers individual factors such as the level of risk of developing a stroke. The study of the individual’s profile as to the evolution of the BP and the habits of the person, may also provide elements of individualization of the diagnosis. Moreover, it is already known that the age and sex can be taken into account ((Osude et al., 2021), (Schoepflin et al., 2021)).

2.1.2 Prescription

It consists in choosing an adequate drug for a hypertensive individual or in changing the current treatment if it is judged ineffective. The way of choosing the drug can be based on some predefined criteria (e.g. gender, age). The Classical strategy considers that the treatments have different effects due to unknown reasons. So, the choice of a treatment can be assimilated as being random. As for the Diagnostic, an Alternative strategy considers different parameters (e.g. risk) for choosing a drug. It is also possible to combine drugs.

2.1.3 Treatment Effect

Not much is known about the prediction of effect of hypertensive drug on BP that would be patient specific. We used the results from the IDEAL trial (Gueyffier et al., 2015), completing those from the Dickinson’s study (Dickerson et al., 1999), supporting that BP reduction is positively correlated with the age for Diuretics (DI) and Calcium Antagonists (CA), and negatively correlated with the age for Beta Blockers (BB) and, in general, for Angiotensin-Converting Enzyme Inhibitors (ACEI). Beyond the link with age, the residual variability has been considered as random noise. In order to model the benefit of a drug, expressions (1) and (2) were used to quantify the treatment effect at the individual level. The expressions 1 and 2 have

been inspired from obtained results in (Gueyffier et al., 2015) concerning the AC inhibitors and the DI. The extrapolation to CA and BB is justified by the correlations observed in (Dickerson et al., 1999). The new BP is calculated differently depending on the group of the drugs and the age of the individual. Indeed, the drugs are classified into two groups: (1) DI, CA, and (2) BB, ACEI, and Sartans (SAR). It is known that SAR have similar effect than ACEI and BB. The first group is more efficient for aged persons, with an effect increasing from 3 to 5% of BP with age, and the second one is better for young persons with an effect decreasing from 5 to 3% with age.

The age of the individuals of the population is greater than 35 and less than 65 years. For the first group, the expression is:

$$F = 0.03 + 0.033 * (age - 35) * 0.02 \quad (1)$$

For the second group, the expression is:

$$F = 0.03 + 0.033 * (65 - age) * 0.02 \quad (2)$$

The effect of the treatment E is calculated with: $F + r$, where r is a randomly generated number with a specific normal distribution. To define a general TS, it is sufficient to specify each of the three dimensions described above. Considering particular criteria will focus on a particular strategy. For that purpose, it is possible to rely on knowledge extracted from recent scientific literature or on empirical acquired knowledge by physicians during their hospital practices. In this work, we relied on the expertise of the doctors we partnered with.

3 MATERIAL AND METHODS

The aim of the proposed approach is to provide a knowledge-based platform for simulating and evaluating TSs on a Realistic Virtual Population (RVP). The simulation consists in launching a number of visits for each individual according to the DPE cycle (see Figure 2).

3.1 Virtual Population

Because of the difficulty in accessing a real dataset, due to ethical and financial considerations, synthetic data are being increasingly used ((Schoepflin et al., 2021), (Richard J. Chen, 2021)). In our case, synthetic data were built based on official French demographic statistics and summarized data from representative observational studies. For that purpose, we used the algorithm that had been developed in (Ivanny,

2018). This was used in (T. and A., 2002) to generate a hypothetical population that reproduced a general practitioner patient list to test the cost effectiveness of different screening strategies. The Algorithm (see Figure 3) allows generating a RVP of a given number of individuals. The individuals have the same

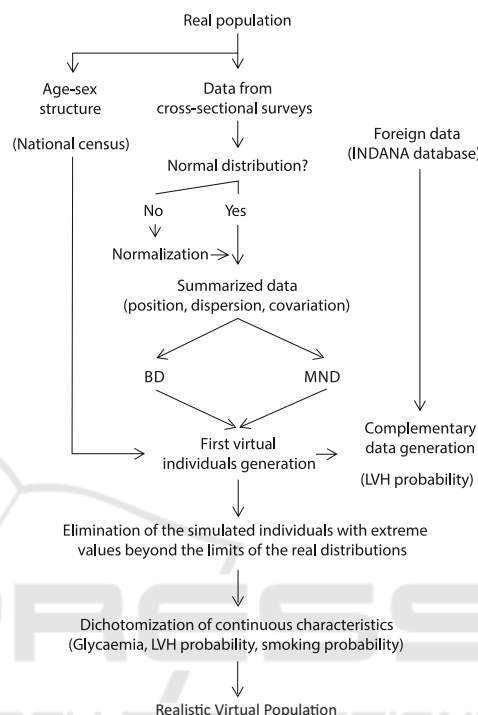

Figure 3: Realistic Virtual Population Algorithm. generation.

age, sex and cardiovascular risk factors profile as the French population aged 35-65 years. For each individual, an identifier is automatically assigned. The remaining individual characteristics are: sex, age, systolic arterial pressure, diastolic arterial pressure, total cholesterol, hdl cholesterol, blood sugar, smoking or non-smoking, and diabetes mellitus. The algorithm is based on a specific variance-covariance matrix. We used it in the proposed approach to generate an RVP for simulating different TSs. The approach has been validated with Hypertension application. When different TSs are simulated, their efficiency can be evaluated in terms of BP evolving, the evolution of the number of treated individuals, the distribution of prescription drugs and, the rate of reducing the risk. Moreover, the public health impact of employing a particular strategy can be quantified depending, on, for example, of number of treated individuals. Comparing the outputs of the TSs allows quantifying and comparing their benefits. The platform is based on the architecture showed in Figure 4. It is composed

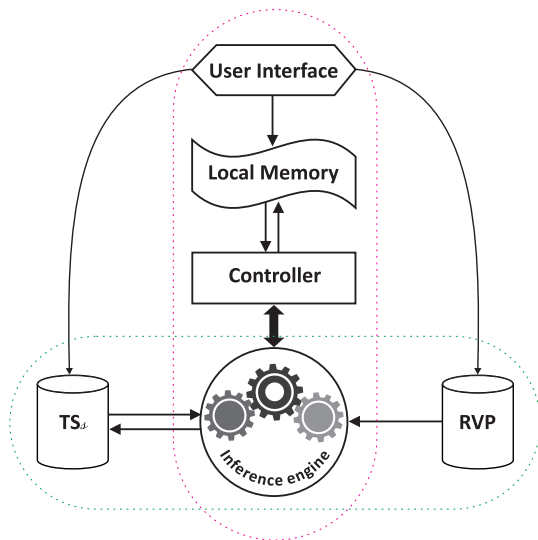

Figure 4: Platform Architecture.

of a rule-base that models the TSs and a Fact-base for representing the RVP. The User Interface allows setting the different parameters and configurations of the application (e.g. the number of visits planned for each individual composing the VRP, the thresholds for BP). The Controller is in charge of controlling a DPE cycle visit for each individual of the RVP. It also treats the requests coming from the User Interface. The Inference Engine triggers the rules (from TSs rule-base) according to their relevance as defined by the Controller. Each of these components is described hereafter.

3.2 TSs Rule-Base

For structuring the TSs, we have opted for the production rules formalism. This choice is motivated by different reasons. It is close to the expert reasoning which is often in the "IF-THEN" form. Additionally, it is expressed in a textual form that is easier to understand. So, it is easy for the experts to adhere to such a formalism. Adding or modifying a production rule simply consists of adding production rules or overwriting the existing ones. The processing and control of the rules are independent of the rules themselves. So, the same Inference Engine is used to process different Rule-bases. The user does not need to know about how the system triggers nor compiles the rules. The most common rules form is the *IF Conditions THEN Action* one, meaning that if *Conditions* are satisfied then *Action* is executed. Other types of rules like the *m of n rules* where, given *n Conditions*, the *Action* is executed if *m conditions* from *n* ($m \leq n$) are satisfied. Also, the

rules can be labeled with a confidence degree or a strength.

For modelling the TSs, the rules are grouped in packages depending on which phase of the DPE Cycle they are part of. Their general form is: *PR: if* (pr_1) (pr_2) ... (pr_i) ...and (pr_n) *then Action*, where:

PR is the name of the production rule and, $pr_i(1 \leq i \leq n)$ is a premise that expresses a parameter constraint, $pr_i = (x_i \text{ op } \alpha_i)$, where x_i is the name of the i^{th} parameter, α_i is its value, and $op \in \{<, >, =, <=, >=\}$ is an operator comparison. Examples of simplified rules are shown in Tables 1. The Diagnostic rule (a) is used to decide whether the individual is hypertensive if his/her Systolic Blood Pressure (SBP) is higher than 140. The prescription rule (b) chooses the BB drug if the individual is under 50 years old. The Effect rule (c) calculates the drug effect for a treated individual who is over 50 years old.

Table 1: Examples of production rules.

<i>if</i> ($PAS > 140$) <i>then</i> (<i>Hypertensive True</i>)	(1)
<i>if</i> (<i>Hypertensive True</i>)($age < 50$) <i>then</i> (<i>Drug BB</i>)(<i>Treated True</i>)	(2)
<i>if</i> (<i>Treated True</i>)($age > 50$) <i>then</i> (<i>Calculate - BP_post - treat</i>)	(3)

3.3 RVP Fact-Base

The RVP is a set of individuals where a list of characteristics is instantiated for each individual. Each individual is represented as a Fact-base in the form: ($c_1 v_1$) ($c_2 v_2$) ... ($c_i v_i$) ... ($c_n v_n$), where: n is the number of characteristics and, v_i is the value of the characteristic named c_i . Table 2 shows examples.

Table 2: Examples of facts from RVP base.

(id 1) (sexe 1) (age 43.60) (pas 111.09) (pad 70.87)(cto 1.96)(hdl 0.45) (glyc 1.17) (dm 79.19)(tab 60.16) (hvg 172.75)
(id 2) (sexe 2) (age 43.38) (pas 142.80) (pad 98.362)(cto 2.34)(hdl 0.29) (glyc 0.90) (dm 87.75)(tab 72.63) (hvg 167.76)
(id 3) (sexe 1) (age 37.0) (pas 125.60) (pad 80.57)(cto 2.22)(hdl 0.36) (glyc 0.740) (dm 72.01)(tab 55.71) (hvg 169.92)

3.4 User Interface

The User Interface allows for adjusting the simulation settings, such as the parameters defining a strategy, the virtual population to employ (by uploading associated text files) and the desired parameters to be extracted as outputs. It is dedicated to the interaction between the system (Controller component) and the user. Its usefulness is threefold:

1. loading the TSs and the RVP, with adequate parameter values.
2. launching the results to extract from the simulation.
3. displaying the results (curves, histograms).

Here is a parameter shortlist which can be set for each execution session: the number of visits, the threshold values for SBP, DBP, and risk, and, the equation coefficients for calculating the treatment effect. Here are some outputs examples:

- Histograms for measuring the optimal drug.
- Curves for measuring the BP evolution.
- The diagnostic rate which represents the numbers of individuals considered hypertensive divided on the number of individuals of the RVP.
- The success rate is the ratio between the number of individuals on treatment for whom the BP is under control, and the number of individuals in treatment.

3.5 Controller

The Controller is in charge of two primary tasks. The first task consists of launching the number of visits for each individual of the RVP, and monitoring their execution according to the DPE cycle. The Controller acts as a metalevel by giving a focus to the Inference Engine. The focus is successively on the Diagnosis rules package, then the Treatment rules package, and finally, the Effect rules package. Thus, all individuals are simulated. The second task launches the calculations of the TSs results needed by the user. The two tasks are performed through production rules. For that purpose, the Controller adds adequate facts in the Local Memory making it possible to trigger the appropriate rules.

3.6 Local Memory

The Local Memory contains the facts and the rules used by the User Interface and the Controller. The rule *R1* is an example of a production rule, from Local Memory, that expresses that it is to launch the

Diagnostic phase of the DPE cycle.

R1: if (DPE_Diag)(Individual ?p) then (process_diag ?p)

The fact *F1* (respectively *F2*) is a fact, from Local Memory, that expresses that it is to calculate the success rate (respectively to switch to the Diagnostic step of DPE Cycle):

F1: (calculate success rate), F2: (DPE_Diag).

3.7 Inference Engine

The Inference Engine is the core component of the platform. It triggers the rules, allowing their actions to be executed. The Action part of a rule consists of adding new facts in the working memory or the execution of a function. This provides great flexibility in what can be done with such rules. This is the reason why the Inference Engine component is used for all the automated processes of the platform. For the implementation purpose, we have used CLIPS² language, which is a rule-based programming language and scripting environment. Such a language is useful for creating Expert Systems and other programs where a heuristic solution is easier to implement than an algorithmic solution. CLIPS provides a list of functions that can be executed in the Action part of the rules. It also allows defining functions for application needs. The CLIPS formalism is based on Propositional Logic and First Order Predicate Calculus. A CLIPS knowledge base is composed of facts which are true or false, and rules, which are triggered according of their relevance by an instance the CLIPS engine. Any proposition (as they are used in Propositional or first order Logic) can be represented as a CLIPS fact. For instance, an individual whose Id is 35, and SBP is expressed as 145mmHG, the two facts (*SBP 145*) and (*Id 35*) are asserted. But, if we want to deal with different person's SBP, one can use a structure (Individual) with two slots (Id and SBP) that describe the Individual entity. The facts become: (*Individual (Id 35)(SBP 145)*). This corresponds very well with the familiar concept of an object with its attributes. The facts (*SBP 145*) and (*Id 35*) are represented as ordered facts whereas the proposition (*Individual (Id 35)(SBP 145)*) is a compound proposition, which is more conveniently represented by an unordered fact.

²<http://www.clipsrules.net/>, accessed on January 11, 2023.

The simple rule *R1* should be triggered if any patient has a SBP equal to 145.

```
(defrule R1 (Individual (Id ?x)(SBP 145)) =>
(printout ?x has a high Systolic Blood Pressure))
```

We can also write the rule *R2* that deals with a false proposition: (defrule *R2* (not (SBP 145)) => (printout SBP value is not 145 !))

Obviously, to express the TSs, we need more complex rules expressions. Let's take the following sample from official guidelines (Graham and AL., 2007) for Hypertension management: "The decision to start hypertensive treatment should be based on two criteria, the level of systolic being greater than 140 and diastolic blood pressure greater than 90". The translation of this guideline into a CLIPS rule (*R3*) could be as follows:

```
(defrule R3
(Individual (Id ?id)(> SBP 140)(> DBP 90)
(> NB_Mesures 3)
=> (Hypertensive ?id Yes))
```

The individuals of the RVP are automatically compiled into facts in the CLIPS syntax. This has been done thanks to a script written in AWK language³. In Figure 4, the oval red dotted line form regroups the components of the architecture that are related to the Structure level. The oval green dotted line form regroups the components of the Implementation level. As shown in Figure 4, the Inference Engine is at the junction between the two levels. To show the feasibility and the usefulness of the approach, the present work focused on a sub-set of Hypertension knowledge.

4 USE-CASE

Our Use-case is related to the management of Hypertension and associated cardiovascular risk. We chose a small subset of european guidelines ((Graham and AL., 2007), (Fagard and AL., 2013)). Two simple TSs were defined to conduct the experiment of the approach with a RVP such as described in section 3.1. The two strategies, a Classical strategy and Alternative strategy, were implemented. Their respective results were quantified to evaluate the benefit of each one in terms of optimal drug prescription, number of avoided

³<https://www.gnu.org/software/gawk/manual/>, accessed on January 11, 2023.

cardiovascular accidents, decreasing BP levels, number of treated individuals, diagnosis rate success (e.g. successful treatment) and more generally, their success rate (that can include elements such as the successful diagnostic).

4.1 Therapeutic Strategy Setting

Each TS is defined by specifying each of the three rules packages: (1) Diagnostic rules, (2) Prescription rules and (3) Treatment Effect rules. Launching a strategy consists of parametrizing the User Interface items by changing the default value(s) assigned to each parameter. The Classical strategy is based on the BP threshold for the diagnosis. For the prescription, it acts in a random way for choosing a drug, based on the hypothesis that the prescriber believes that all the drugs are similar and produce different effects for different individuals without any known reasons. The Alternative strategy considers the BP threshold, age, gender, and cardiovascular risk when choosing an adequate drug. For the prescription, it assumes that the prescriber believes that the effect of the treatment depends on individual parameters. Some drugs (ACEI, SAR, BB) are more efficient for young people, and some others (DI, CA) are more suitable for people over 50. The same Treatment Effect rules were used in order to be able to quantify the contrast between the two strategies. The two strategies were simulated with the same RVP.

4.2 Experimentation

A same RVP of 20.000 individuals was used to conduct the simulation of each strategy. This size is easy to modify since the RVP is automatically generated thanks to the algorithm described in (Figure 3). For each strategy, ten visits were planned for each individual of the RVP. At each visit, the number of succeeded treatments and the mean of the measured BP were calculated. At the end of the simulation, we plotted for each strategy, the curve representing the evolution of the BP (Figure 5), the histograms representing the number of prescriptions (Figure 6 and 7), the number of treated individuals at each visit (Table 3) and, the absolute risk at each visit (Table 4). We evaluated the gain when official recommendations (Classical strategy) are respected. The conducted experi-

Table 3: Number of treated individuals.

Strategy	v4	v6	v8	v10
Alternative	2407	2637	2836	2953
Classical	2397	2657	2626	2998

ments showed how we can quantify the efficiency of a particular strategy according to selected parameter values. The curves of Figure 5 represent the evolution of the mean of measured BP over the time for individuals which are under treatment for each strategy. The experiments were also used to quantify the

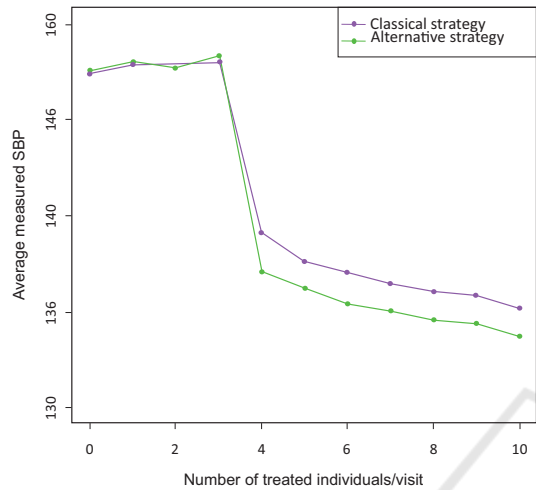

Figure 5: Blood pressure evolving.

superiority of one of the two strategies under defined hypothesis. Throughout the visits, a pressure difference of 1.5 mmHg is observed; showing that the alternative strategy is slightly better than the classical one. Indeed, the average BP of the population after ten visits is greater for the Classical strategy than for the Alternative strategy. Table 3 visualizes the number of treated individuals at each visit, allowing to know the number of sick individuals in the RVP. Unlike the diagnostic method based solely on BP, we see that fewer patients were treated when the diagnosis considers the risk. When the treatment is based on BP, the goal is twofold: to reduce the BP and the risk of an accident. Considering the reduction of the risk of accidents at each visit makes it possible to visualize the number of avoided accidents. Table 4 shows that the risk is lower with the Alternative strategy (A), than the Classical one (C) meaning that the number of avoided accidents is higher. Another way to quantify the efficiency of the strategies is the way of choosing a treatment. More precisely, it is the ability of a strategy to identify the optimal treatment for each individual. The optimal treatment is the one that gives the high-

Table 4: Absolute risk at each visit.

Strategy	v5	v6	v7	v8	v9
A	0.022	0.026	0.021	0.015	0.013
C	0.0195	0.0194	0.0193	0.0194	0.0195

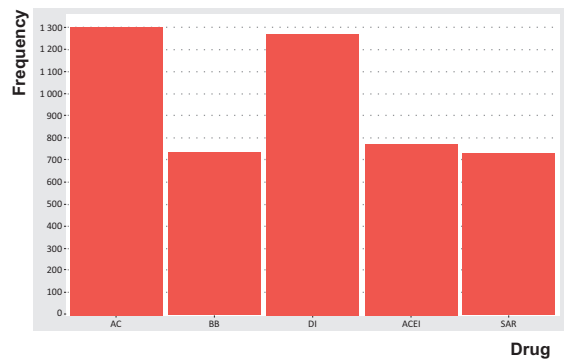

Figure 6: Optimal treatments for people over 50 years with Classical strategy.

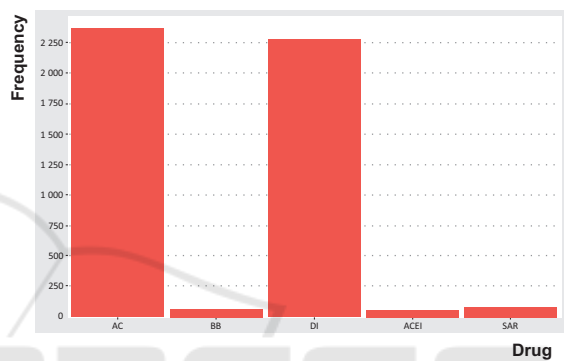

Figure 7: Optimal treatments for people over 50 years with Alternative strategy.

est BP decrease during the visits. Figure 6 shows the results of optimal treatments for individuals over 50 years during the simulation of the Classical strategy, while Figure 7 shows the results of optimal treatments for individuals over 50 years during the simulation of the Alternative strategy.

We note the dominance of AC and DI drugs in both strategies, but it is much clear in the Alternative strategy. The dominance observed in the Alternative strategy is, obviously, due to the fact that it is based on an age-appropriate prescription. However, it is important to reiterate that the simulation is neither used for optimizing the treatment (such as it is done in (Bennett and Hauser, 2013)) nor for discovering new features of Hypertension or its treatment. The aim of the simulation is to:

1. Illustrate the consequences of considering some scientific facts, ignored in the current guidelines.
2. Estimate the extent of BP control improvement through the application of new rules.

5 DISCUSSION

Thanks to the developed platform, a Classical and an Alternative strategies were simulated with a Realistic virtual population. Then, their results were analyzed and compared. The conducted experiments showed how we can quantify the efficiency of a particular therapeutic strategy according to selected parameters. The originality and the strengths of our approach are numerous. The prescription, diagnostic and drug effect rules are the input of the system. These rules can be introduced and modified by non-programmers people, allowing prescribers to fully test their own rules. This is due to the fact that the AWK script (used to compile the RVP) and, the production rules are an inputs of the platform. The structure of the facts can be modified by adapting the script. Moreover, the expertise should be written in XML language (CLIPS supports it), so it is not necessary for the user to know about the syntax of CLIPS rules and facts in order to proceed to any modification. This allows adding new parameters with new rules that will process these parameters. Since all the expertise is written in production rules, the platform can be applied to any other application domain. Our approach provides a complement to the statistical tools that often impose a rigid data format and manipulation requiring the mastery of the tool. In fact, the proposed platform used production rules for modelling the therapeutic process, which is close to human deduction reasoning, as employed by physicians. Note that our platform allowed different kinds of experimentations that have not been reported here. In this paper, we reported only a part of the carried ones. The source code of the platform, details about how to parametrize an experimentation, and a sample of the used data and expertise can be found on: <https://github.com/nabchiche/ISThMe.git>. To the best of our knowledge, this work is the first that proposes an approach that combines such advantages. Existing approaches are based on meta-analysis (Gao, 2019), randomized clinical (Duffy J and RJ, 2017), and/or on specific mathematical modelling ((Cottura et al., 2020), (Gumel et al., 2002)). Most of them are disease-specific or dedicated to sub-problems of a disease. More recently, Machine Learning has gained in interest due to their prediction power (Phan et al., 2022). Unfortunately, they suffer from the Blax-box effect that make them unusable, especially when evidence is needed to take a decision, such as in medicine.

6 CONCLUSION AND PERSPECTIVE

We have presented an approach for studying and evaluating the efficiency of therapeutic strategies in Hypertension management. The approach proposed a platform where the knowledge describing the therapeutic strategies had been modelled by means of production rules. This makes it possible to modify the strategies in a declarative way, i.e., without modifying the source code of the application.

Current work concerns the addition of more complex expertise so that one can deal with comorbidities. Hypertension is often associated with other diseases (e.g., diabetes). Comorbidities can be considered by implementing the ability to use different effect models of drugs that consider comorbidity factors (e.g. by considering kinetic models ((Holford and Sheiner, 1982), (Donnelly et al., 1992))). Moreover, it should be possible to consider the variability of the BP according to the day-night rhythm or the seasons ((Giles, 2006), (Chen and Yang, 2015))). In the current version of the system, the knowledge base related to the official guidelines had been manually extracted. An open direction that would seem natural is to compile the expertise into rules and facts directly usable by CLIPS; so, the human intervention would be minimal. For that purpose, the work done in (Isern et al., 2007) could be a precious source of inspiration. The authors provide a flexible framework to follow the execution of clinical guidelines based on an ontology and a multi-agent system. Another idea to explore is the use text of mining techniques for buildings production rules from clinical guidelines. The proposed approach would be very helpful to implement a framework for benefit-risk appraisal of medicines in order to provide transparent and responsible benefit-risk decision making model as described in (Filip Mussen, 2009).

ACKNOWLEDGMENTS

We thank the National Association of Research and Technology for funding this work, Ivanny Marchant who helped to generate the VRP, and Nora Abchiche-Habtoun for helping to produce high-quality images.

REFERENCES

Bennett, C. C. and Hauser, K. (2013). Artificial intelligence framework for simulating clinical decision-making: A

- markov decision process approach. *Artificial Intelligence in Medicine*, 57(1):9–19.
- Chen, L. and Yang, G. (2015). Recent advances in circadian rhythms in cardiovascular system. *Frontiers in Pharmacology*, 6.
- Cottura, N., Howarth, A., Rajoli, R. K., and Siccardi, M. (2020). The current landscape of novel formulations and the role of mathematical modeling in their development. *The Journal of Clinical Pharmacology*, 60(S1):S77–S97.
- Dickerson, J., Hingorani, A., Ashby, M., Palmer, C., and Brown, M. (1999). Optimisation of antihypertensive treatment by crossover rotation of four major classes. *Lancet*, 353:2008–2013.
- Donnelly, R., Elliott, H., and Meredith, P. (1992). Antihypertensive drugs: Individualized analysis and clinical relevance of kinetic-dynamic relationships. *Pharmacology & Therapeutics*, 53(1):67–79.
- Duffy J, Hirsch M, K. A. G. C. P. L. P. M. S. M. W. P. K. K. Z. S. and RJ, M. (2017). Outcome reporting across randomised controlled trials evaluating therapeutic interventions for pre-eclampsia. *BJOG: An International Journal of Obstetrics & Gynaecology*, 124(12):1829–1839.
- Fagard, R. and AL. (2013). 2013 esh/esc guidelines for the management of arterial hypertension. *European Heart Journal*, pages 1–72.
- Filip Mussen, Sam Salek, S. W. (2009). *Benefit-Risk Appraisal of Medicines: A Systematic Approach to Decision-making*. Wiley-Blackwell.
- Gao Q, Gao W, Xia Q, Xie C, Ma J, Xie L. (2019). Effectiveness of therapeutic strategies for patients with neck pain: Protocol for a systematic review and network meta-analysis. *Medicine*, 98(11):e14526.
- Giles, T. (2006). Circadian rhythm of blood pressure and the relation to cardiovascular events. *Journal of hypertension. Supplement : official journal of the International Society of Hypertension*, 24:S11–6.
- Graham, I. and AL. (2007). European guidelines on cardiovascular disease prevention in clinical practice: executive summary. *European Heart Journal*.
- Gueyffier, F., Subtil, F., Bejan-Angoulvant, T., Baguet, J., Boivin, J., Mercier, A., Leftheriotis, G., Gagnol, J., Fauvel, J., Giraud, C., Bricca, G., Maucort-Boulch, D., and Erpeldinger, S. (2015). Can we identify response markers to antihypertensive drugs? first results from the ideal trial. *Journal of Human Hypertension*, pages 7–22.
- Gumel, A., Zhang, X.-W., Shivakumar, P., Garba, M., and Sahai, B. (2002). A new mathematical model for assessing therapeutic strategies for hiv infection. *Journal of Theoretical Medicine*, 4.
- Holford, N. H. and Sheiner, L. B. (1982). Kinetics of pharmacologic response. *Pharmacology & Therapeutics*, 16(2):143–166.
- Isern, D., Sánchez, D., and Moreno, A. (2007). Hecase2: a multi-agent ontology-driven guideline enactment engine. In *CEEMAS 2007*, volume 4696, pages 322–324, Leipzig, Germany. Springer Verlag.
- Ivanny, M. (2018). *Optimization of sudden cardiac death prevention in type 2 diabetes in France : a public health simulation study on a realistic virtual population*. PhD thesis, UCB Lyon 1.
- Kotecha, R. R., Hsu, D. J., Lee, C.-H., Patil, S., and Voss, M. H. (2021). In silico modeling of combination systemic therapy for advanced renal cell carcinoma. *Journal for ImmunoTherapy of Cancer*, 9(12).
- Nayyar, A., Gadhavi, L., and Zaman, N. (2021). Chapter 2 - machine learning in healthcare: review, opportunities and challenges. In Singh, K. K., Elhoseny, M., Singh, A., and Elngar, A. A., editors, *Machine Learning and the Internet of Medical Things in Healthcare*, pages 23–45. Academic Press.
- Osude, N., Durazo-Arvizu, R., Markossian, T., Liu, K., Michos, E. D., Rakotz, M., Wozniak, G., Egan, B., and Kramer, H. (2021). Age and sex disparities in hypertension control: The multi-ethnic study of atherosclerosis (mesa). *American Journal of Preventive Cardiology*, 8:100230.
- Patel, K., Dodds, M., Gonçalves, A., Kamal, M. A., Rayner, C. R., Kirkpatrick, C. M., and Smith, P. F. (2021). Using in silico viral kinetic models to guide therapeutic strategies during a pandemic: An example in sars-cov-2. *British Journal of Clinical Pharmacology*, 87(9):3425–3438.
- Phan, A.-C., Phan, T.-C., and Trieu, T.-N. (2022). A systematic approach to healthcare knowledge management systems in the era of big data and artificial intelligence. *Applied Sciences*, 12(9).
- Richard J. Chen, Ming Y. Lu, T. Y. C. D. F. K. W. . F. M. (2021). Synthetic data in machine learning for medicine and healthcare. *Nature Biomedical Engineering*, 5:493–497.
- Roth, G. A. and al. (2020). Global burden of cardiovascular diseases and risk factors, 1990–2019: Update from the gbd 2019 study. *Journal of the American College of Cardiology*, 76(25):2982–3021.
- Sackett, D. L., Rosenberg, W. M. C., Gray, J. A. M., Haynes, R. B., and Richardson, W. S. (1996). Evidence based medicine: what it is and what it isn't. *BMJ*, 312(7023):71–72.
- Schoepflin, D., Holst, D., Gomse, M., and Schüppestuhl, T. (2021). Synthetic training data generation for visual object identification on load carriers. *Procedia CIRP*, 104:1257–1262. 54th CIRP CMS 2021 - Towards Digitalized Manufacturing 4.0.
- Schreiber, G., Akkermans, H., Anjewierden, A., de Hoog, R., Shadbolt, N. R., Van de Velde, W., and Wielinga, B. J. (1999). *Knowledge Engineering and Management: The CommonKADS Methodology*. The MIT Press.
- Sheridan, D. J. and Julian, D. G. (2016). Achievements and limitations of evidence-based medicine. *Journal of the American College of Cardiology*, 68(2):204–213.
- Shortliffe, E. (1976). *Computer-Based Medical Consultations: MYCIN*. Elsevier/North Holland, New York.
- T., M. and A., R. (2002). Resource implications and health benefits of primary prevention strategies for cardio-

vascular disease in people aged 30-74: mathematical modeling study. *BMJ*, pages 325–197.

Troche, C. J., Paltiel, A. D., and Makuch, R. W. (2000). Evaluation of therapeutic strategies: A new method for balancing risk and benefit. *Value in Health*, 3(1):12–22.

Unger, T., Borghi, C., Charchar, F., Khan, N. A., Poulter, N. R., Prabhakaran, D., Ramirez, A., Schlaich, M., Stergiou, G. S., Tomaszewski, M., Wainford, R. D., Williams, B., and Schutte, A. E. (2020). 2020 international society of hypertension global hypertension practice guidelines. *Hypertension*, 75(6):1334–1357.

